

# Collections23







*"Eri qui quando sei arrivato,  
resterai qui quando te ne andrai"*

*"You were here when you came,  
and you will stay here when you leave"*

Si dice che l'uomo moderno sia colui che è capace di dialogare con le nuvole tenendo i piedi ben piantati per terra.

Vittorio Marelli è sempre stato così.

Fantasia e concretezza, che insieme alla passione ed alla perseveranza, diventano la miscela magica capace di prendere per mano un'idea e condurla al suo compimento.

Una vita dedicata ad immaginare e creare divani e poltrone. Un lavoro lungo mezzo secolo, guidato da un solo dogma: qualità, bellezza e cultura, sempre.

È così anche per il suo ultimo progetto che inaugura questo catalogo.

Seguire la luce del suo sguardo, appassionato e fiero, sarà il modo per dire Grazie.

*They say a modern man has his head in the clouds  
and his feet firmly on the ground.*

*Vittorio Marelli was always like this.*

*A fusion of imagination and practicality, when combined with passion  
and persistence, generates the magnetic force capable of grasping  
an idea and guiding it toward its realization.*

*A life dedicated to imagining and crafting sofas and armchairs.  
A labor of love that has lasted for half a century, defined and directed by a steadfast principle:  
excellence, aesthetics, and culture, without exception.*

*This is also true of his last project, which inaugurates this new catalog.*

*Following the light of his gaze, passionate and proud,  
will be the way to say Thank you.*

Scegliere un divano e una poltrona Marac è come una luce accesa dietro la porta: ti dice che sei a casa. E stai bene.

Choosing a sofa or an armchair made by Marac is like a light on your door: it shows that you are home. And feel well.

#### Sofas



Vittorio 6



Cloud 18



Mistral 28



Aland 38

#### Armchairs



Aland 50



Bumper 52



Bumper Lounge 54



Dover 56

#### Complements



Island 58



# Vittorio

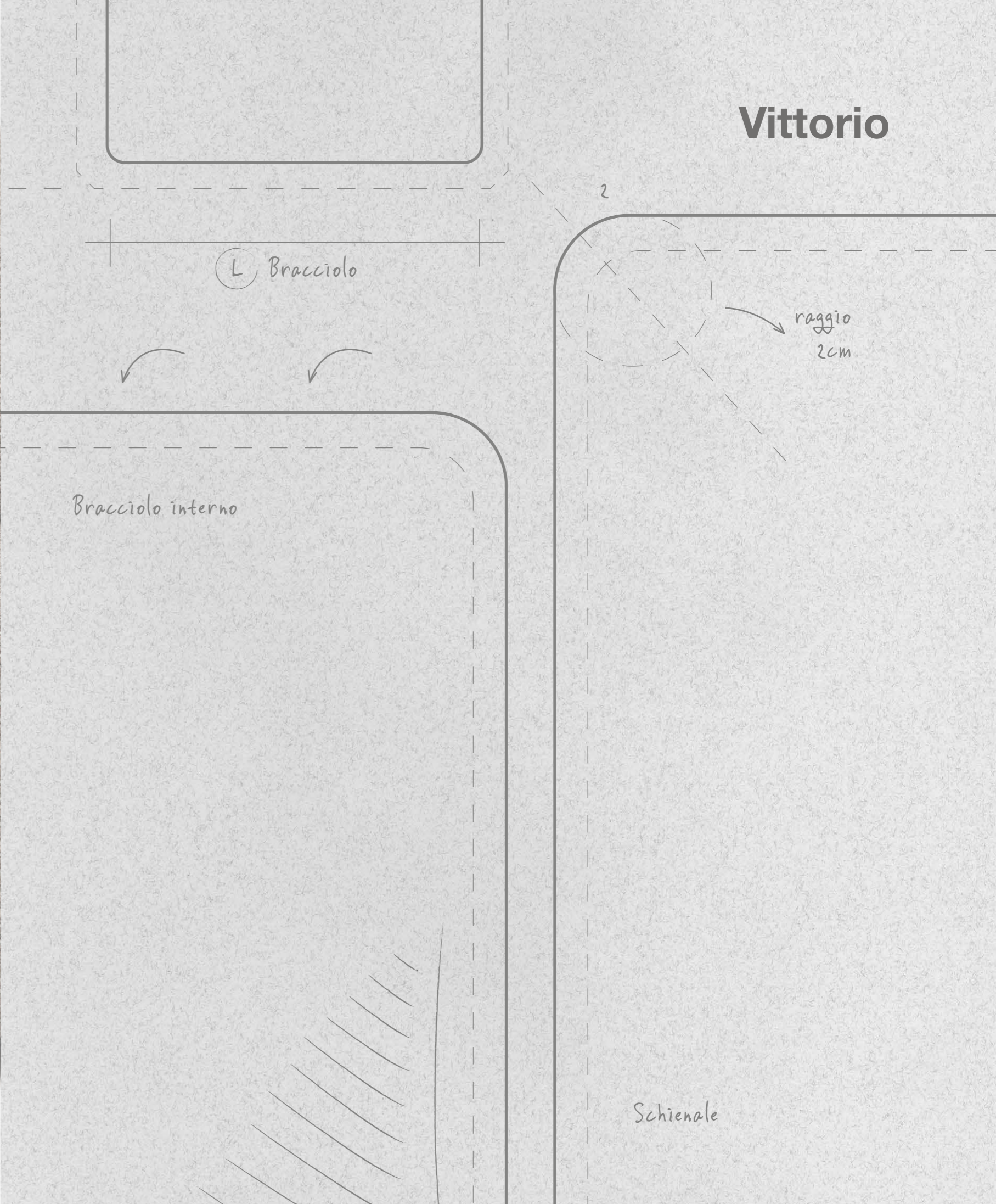



**VITTORIO** | Left element 190 cm, Long Corner 190 cm and Open Right element 160 cm

Fabric Thuy color 4 / Tortora - Small cushions Fabric Dhogar color 14 / Zolfo

**LESLIE** | Swivel Armchair 72cm, Fabric Dhogar color 14 / Zolfo

**ISLAND** | Coffee Table, 130x100x20h cm, matt lacquered finish color Muschio

**BOULEVARD** | Coffee Table, 90x90x32h cm, matt lacquered finish color Pepe and Ø30x46h cm Dark Grey Stone finish

Console, 150x35x42h cm, Dark Grey Stone finish

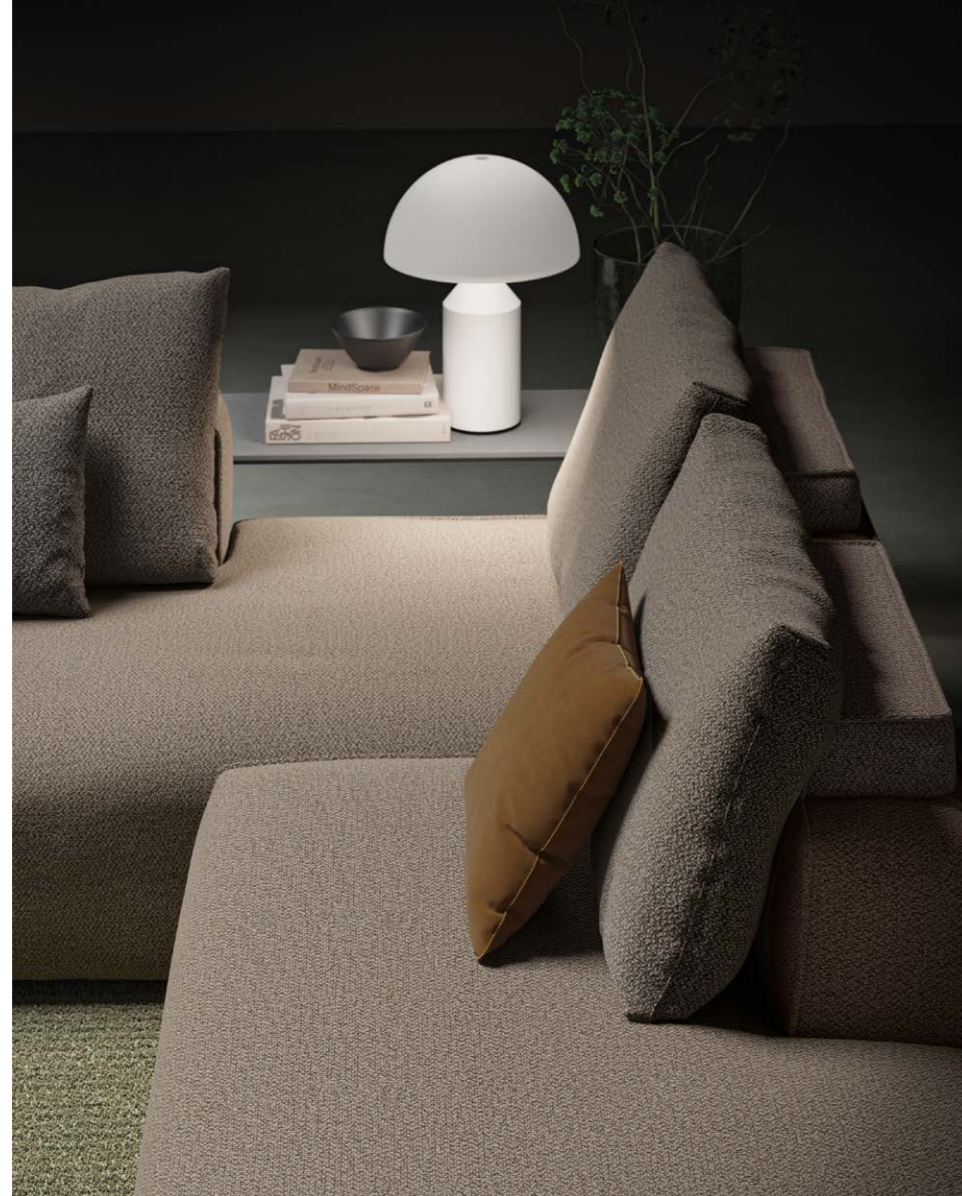

**VITTORIO** | Left element 210 cm and Chaise Longue 210 cm  
Fabric Thuy color 4 / Tortora - Small cushions Leather Nabuk color Conchiglia  
**LESLIE** | Swivel Armchair 72cm, Fabric Dhogar color 14 / Zolfo  
**LAIN** | Pouf, 100x75x38h cm, Fabric Dhogar color 14 / Zolfo  
**BOULEVARD** | Console 150x35x42h cm Candoglia Rock finish  
**MIK** | Coffee Table 32x32x35h and 45h cm, matt lacquered finish color Muschio







**VITTORIO** | Left element 210 cm and Chaise Longue 190 cm  
Fabric Thuy color 4 / Tortora – Small cushions Fabric Dhogar color 14 / Zolfo  
**LESLIE** | Swivel Armchair, Fabric Dhogar color 14 / Zolfo  
**BOULEVARD** | Coffee Table, ø30 x 46h cm matt lacquered finish color Pepe  
**ISLAND** | Coffee Table, 130x100x20 cm, matt lacquered finish color Muschio



VITTORIO | Sofa 260 cm - Fabric Thuy color 4 / Tortora

BOULEVARD | Side Table, 60x30x42h cm Lava Rock finish

MIK | Coffee Table, 32x32x35h cm, matt lacquered finish color Muschio



VITTORIO | Right element 210 cm and Open Left element 160 cm

Fabric Thuy color 4 / Tortora - Small cushions Fabric Dhogar color 14 / Zolfo

ISLAND | Coffee Table, 130x100x20 cm and Top 80x80x12h cm, gloss and matt lacquered finish color Muschio

BOULEVARD | Consolle, 150x35x42h cm, Lava Rock finish

MIK | Coffee Table, 32x32 x 35 h and 45 h cm, matt lacquered finish color Muschio





# Cloud

bracciolo sx

raggio  
3cm

fronte bracciolo



**CLOUD** | Left element 135 cm, Pouf 115x115 cm, Central element 100 cm and Chaise longue 160 cm  
Leather Siviglia color 1028 / Verderame - Small cushions Senky color 10 / Phard  
**BOULEVARD** | Coffee Table, 90x90x32h cm, Lava Rock finish  
**MIK** | Coffee Table, 32x32x35h and 45h cm, gloss lacquered finish color Mattone

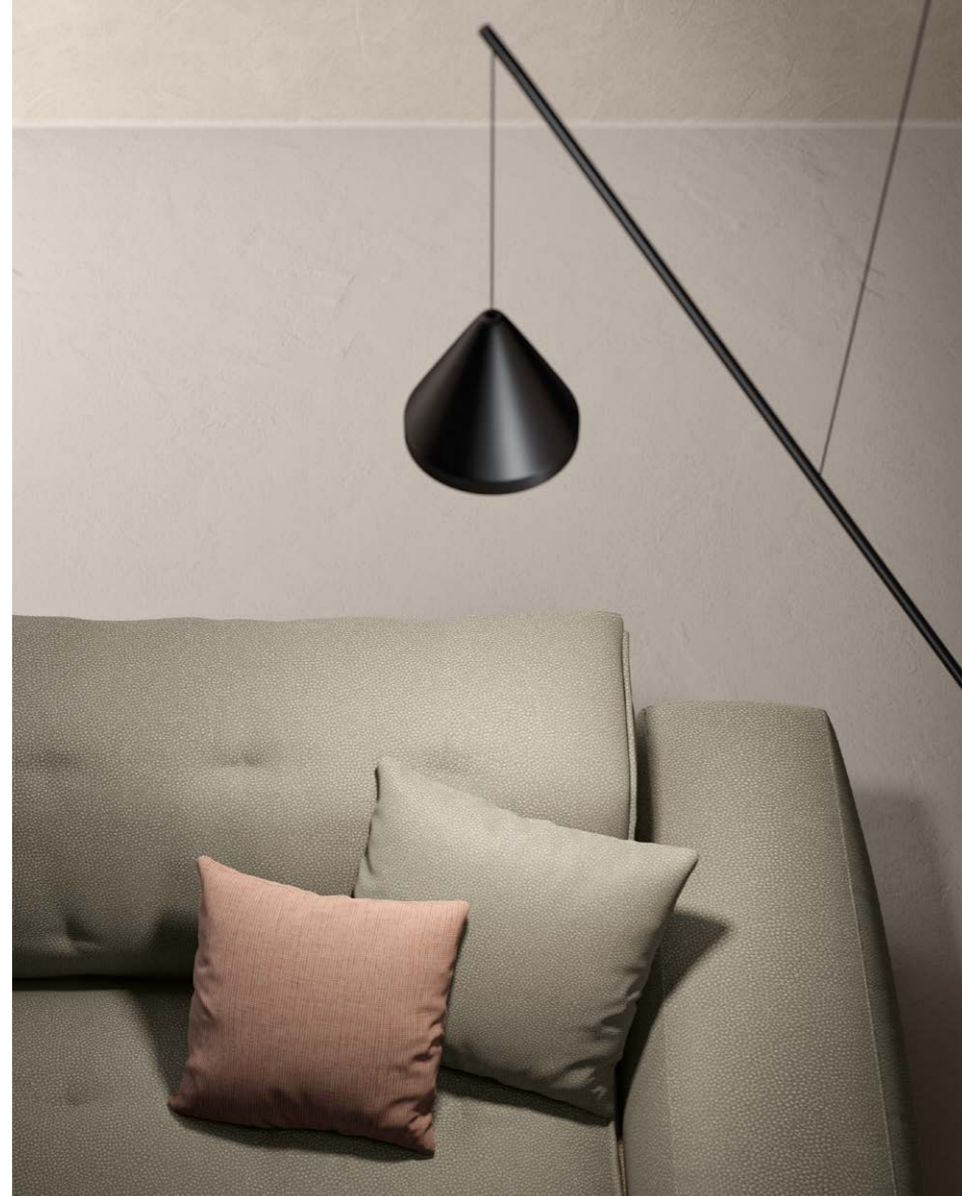

**CLOUD** | Left element 135 cm, Central element 100 cm and Pouf 115x115 cm  
Fabric Senky color 8 / Asfalto - Small cushions Senky color 10 / Phard  
**BOULEVARD** | Coffee Table, 90x90x32h cm, Lava Rock finish  
**MIK** | Coffee Table, 32x32x35h, gloss lacquered finish color Mattone



**CLOUD** | Sofa 250 cm

Fabric Senky color 8 / Asfalto

**ISLAND** | Coffee Table, 130x100x20h cm and Top 130x50x12h cm, gloss and matt lacquered finish color Pepe

**BOULEVARD** | Coffee Table, ø30x46h cm, gloss lacquered finish color Mattone

**CLOUD** | Left element 135 cm, Central element 100 cm, Pouf 115x115 cm and Right element 135 cm

Fabric Senky color 8 / Asfalto - Small cushions Senky color 10 / Phard

**ISLAND** | Coffee Table, 130x100x20h cm, Oakwood Natural color finish and Top 130x50x12h cm, matt lacquered finish color Mattone

**BOULEVARD** | Coffee Table, ø30x46h cm, matt lacquered finish color Pepe





# Mistral

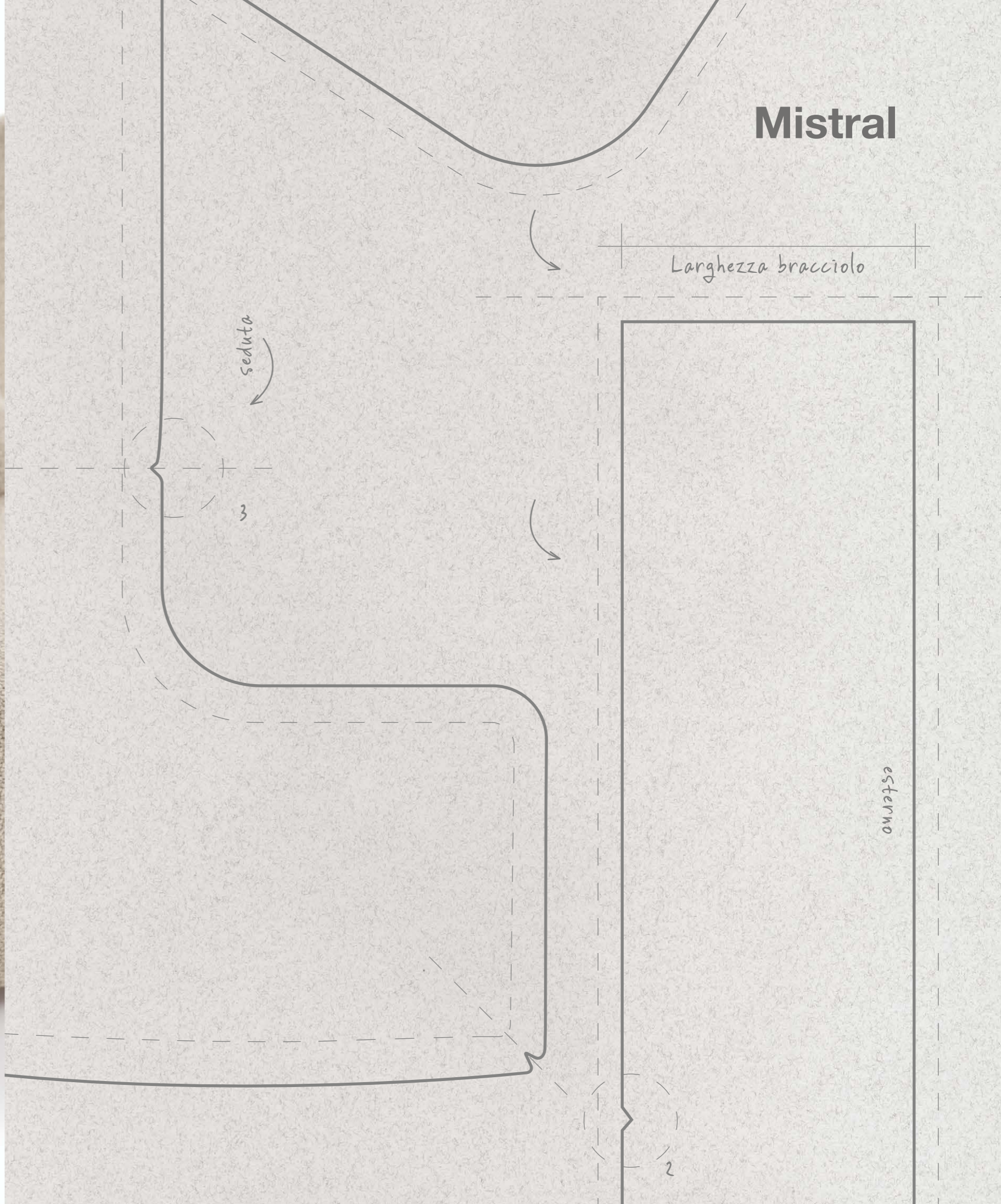





**MISTRAL** | Right element 135 cm, Long Corner 215 cm, Central element 100 cm and Pouf 115x115 cm  
Fabric Baltimora color 4 / Nocciola - Small cushions Fabric Thuy color 1 / Latte  
**DOVER** | Armchair, Fabric Dhogar color 23 / Ombra  
**ISLAND** | Coffee Table, 130x100x20h cm, Oakwood, Walnut color finish  
**BOULEVARD** | Coffee Table, ø30x46h cm, Lava Rock finish  
**PANTHEON** | Rug, 300x400 cm, color 82187 / Tortora

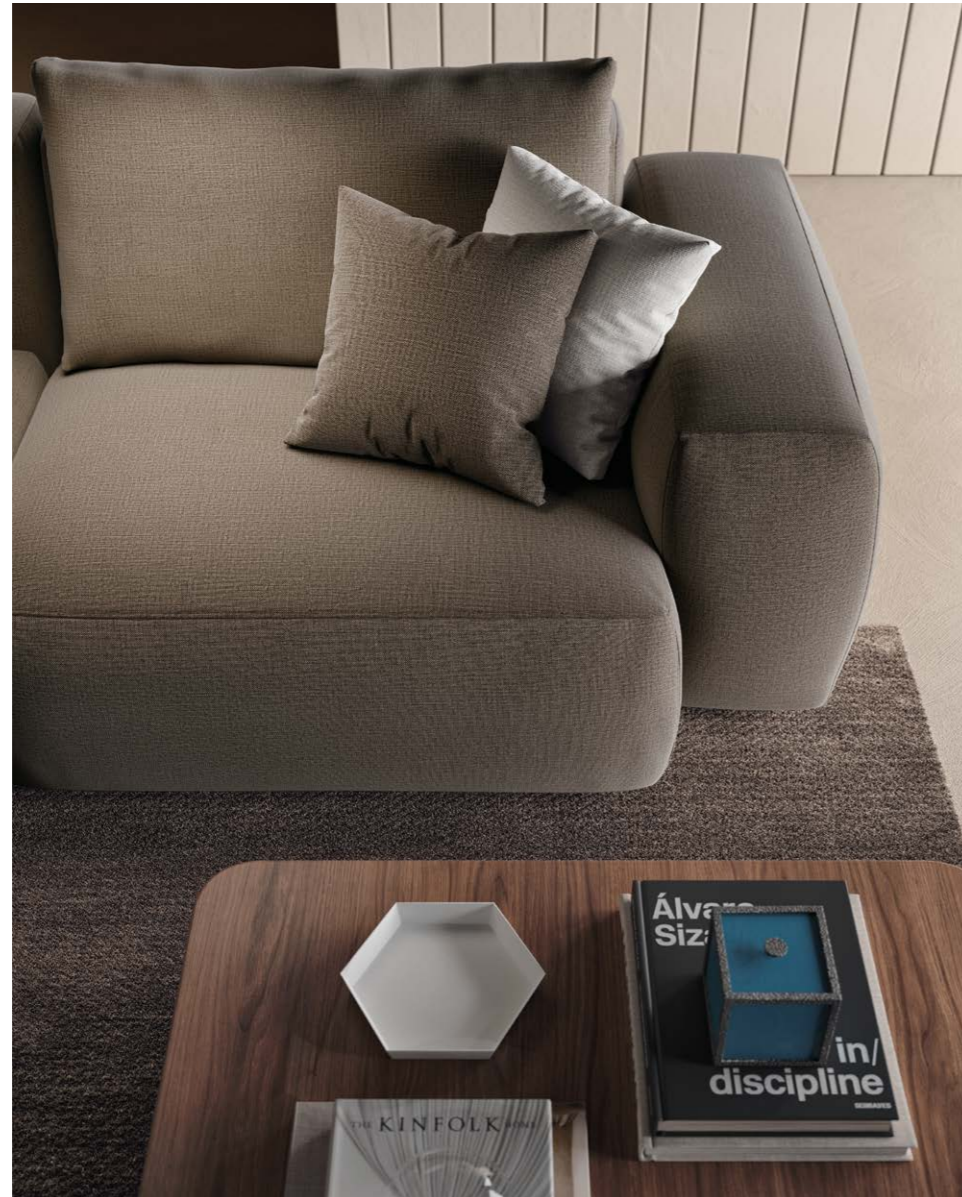



**MISTRAL** | Right element 135 cm, Central element 100 cm and Chaise Longue 160 cm  
Fabric Thuy color 1 / Latte - Small cushions Fabric Dhogar color 23 / Ombra  
**ISLAND** | Coffee Table, 130x100x20h cm and Top ø80x12h cm, gloss lacquered finish color Pepe  
**BOULEVARD** | Coffee Table, 30x30x46h cm and Side Table 60x30x42h cm matt lacquered finish color Oltremare

MISTRAL | Sofa 250 cm

Fabric Thuy color 1 / Latte - Small cushions Fabric Dhogar color 23 / Ombra

BOULEVARD | Coffee Table, ø30x46h cm, matt lacquered finish color Oltremare





# Aland

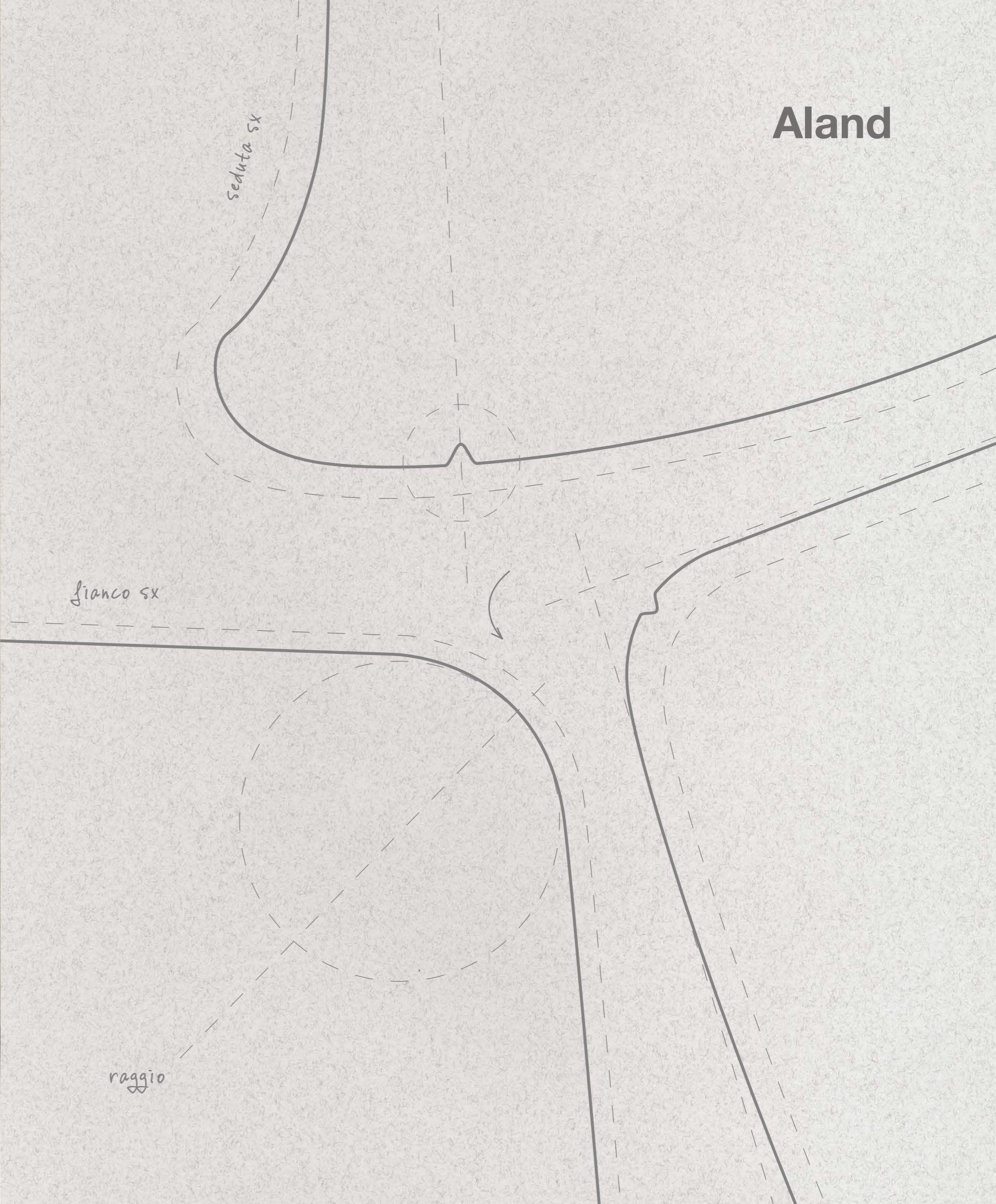



**ALAND** | Sofa 265 cm  
Fabric Barnum color 8 / Giada  
**BUMPER** | Swivel Armchair, Fabric Senky color 5 / Crusca and leather Nappa color Cuoio  
**BOULEVARD** | Coffee Table, 90x90x32h cm, Lava Rock finish  
**MIK** | Coffee Table, 32x32x35h cm, gloss lacquered finish color Mattone



**ALAND** | Sofa 245 cm  
Fabric Senky color 5 / Crusca - Small cushions Senky color 10 / Phard  
**MIK** | Coffee Table, 32x32x45h cm, gloss lacquered finish color Mattone



**ALAND** | Sofa 245 cm  
Fabric Senky color 5 / Crusca - Small cushions Senky color 5 / Crusca  
**ALAND** | Armchair, Fabric Barnum color 8 / Giada  
**BOULEVARD** | Coffee Table, 32x32x45h cm, 90x90x32h cm, Dark Grey Stone finish  
**MIK** | Coffee Table, 32x32x45h cm, gloss lacquered finish color Mattone







ALAND | Right element 185 cm and Chaise Longue 220 cm

Fabric Barnum color 2/ Corda - Small cushions Fabric Dhogar color 22/ Blu

BOULEVARD | Coffee Table, 90x90x32h cm, matt lacquered finish color Pepe and Ø30x46h cm Lava Rock finish  
Console, 150x35x42h cm, Dark Grey Stone finish





## Aland\_Armchair



ALAND | Armchair, Fabric Thuy color 6 / Mattone

<ALAND | Armchair, Fabric Thuy color 6 / Mattone

<MIK | Coffee table, 32x32x45h cm, matt lacquered finish color Pepe

# Bumper



**BUMPER** | Swivel Armchair, Fabric Senky color 5 / Crusca and leather Nappa color Cuoio

**BUMPER** | Swivel Armchair, Fabric Senky color 5 / Crusca

**>BUMPER** | Armchair, Fabric Senky color 5 / Crusca and leather Siviglia color Ebanò

**>MIK** | Coffee table, 32x32x45h cm, matt lacquered finish color Mattone





# Bumper\_Lounge



BUMPER LOUNGE | Lounge chair, Fabric Paddy color 11 / Grigio  
ELLIOT COLORS | Coffee Table, ø42x46h cm, gloss lacquered finish color Mattone  
<BUMPER LOUNGE | Lounge chair, Fabric Paddy color 9 / Grafite and leather Nappa color Antracite  
<ELLIOT COLORS | Coffee Table, ø42x46h cm, gloss lacquered finish color Mattone

# Dover



DOVER | Armchair, Fabric Dhogar color 3 / Polvere  
>DOVER | Armchair, Fabric Barnum color 2 / Corda  
>ISLAND | Coffee Table 130x100x20h cm, Oakwood, Walnut color finish  
>BOULEVARD | Coffee Table, Ø30x46h cm Lava Rock finish





# Island



ISLAND | Coffee Table, 130x100x20h cm, Oakwood, Walnut color finish with Top 130x50x12h cm and ø 80x12h cm gloss lacquered finish color Mattone and Pepe  
<ISLAND | Coffee Table, 130x100x20h cm with Top ø80x12h cm gloss lacquered finish color Mattone



ISLAND | Collection of Coffee Tables .  
For dimensions and finishes see page 75



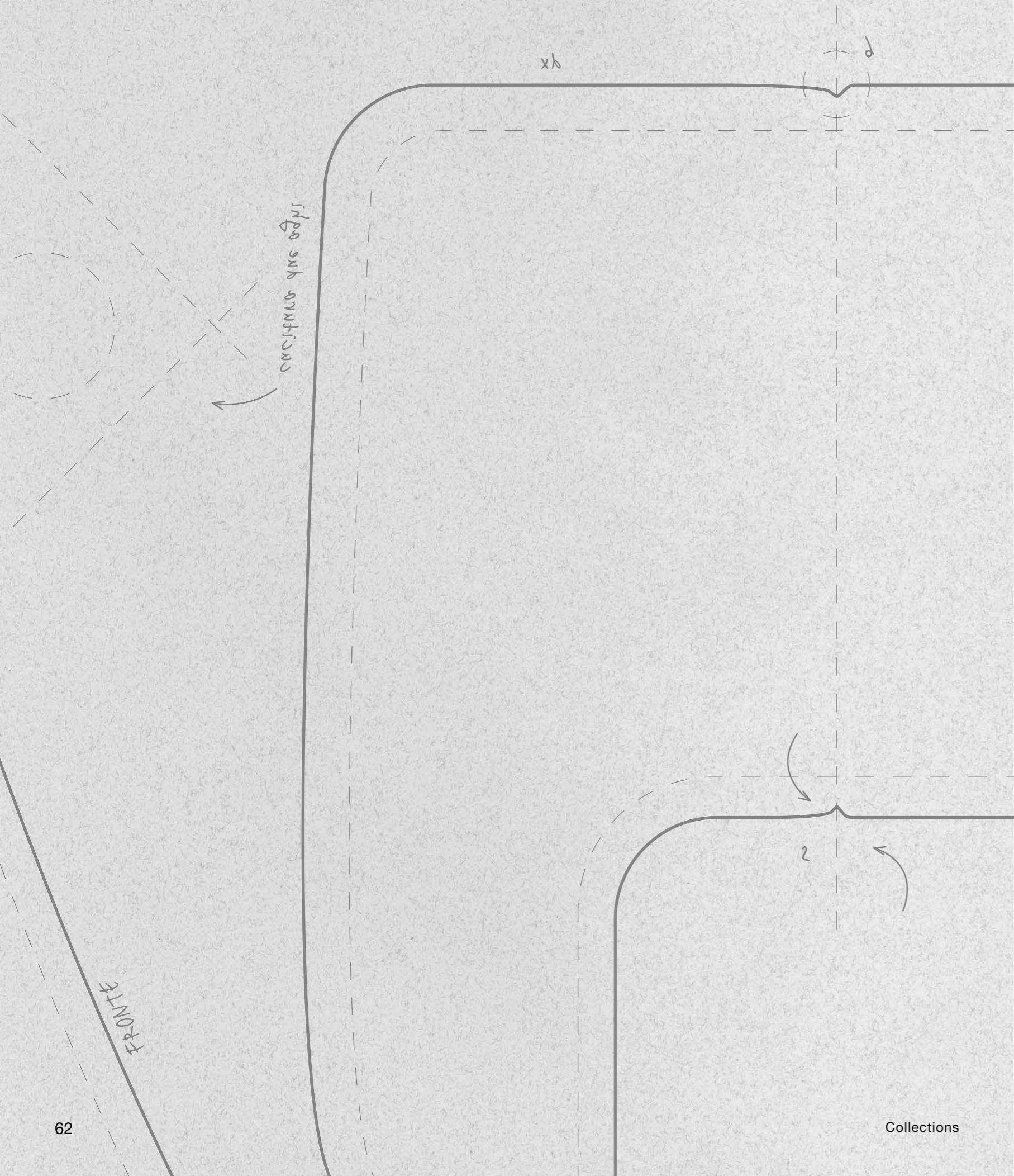

Technical data  
Technische daten

# Vittorio

Sofa



Design\_Vittorio Marelli

**STRUTTURA** | legno di abete (Picea Abies) e multistrato, con cinghie elastiche.

**IMBOTTITURA STRUTTURA** | poliuretano espanso rivestito con fibra in poliestere resinata da 200 gr/m2 accoppiata a tessuto in poliestere elasticizzato.

**SEDUTA** | poliuretano espanso a densità differenziate rivestito con fibra in poliestere resinata da 200 gr/m2 accoppiata a tessuto in poliestere elasticizzato.

**CUSCINI SCHIENALE** | fodera in 100% cotone imbottita con microsfere di poliestere "rollofil".

**PIEDI** | estrusione in alluminio, finitura color nickel nero.

**RIVESTIMENTO** | completamente sfoderabile in tessuto, fisso in pelle.

**FRAME** | fir-wood (Picea Abies) and plywood with elastic straps.

**FRAME PADDING** | polyurethane foam covered with 200gr/m2 resin-bonded polyester coupled with elastic polyester fabric.

**SEAT** | polyurethane foam with different density layers covered with 200gr/m2 resin-bonded polyester coupled with elastic polyester fabric.

**BACK CUSHIONS** | 100% cotton cover padded with "rollofil" polyester.

**FEET** | aluminium extrusion with black nickel finish.

**COVERS** | completely removable with fabric, fixed with leather.

**GESTELL** | Massive Fichte (Picea Abies) mit Multiplex, bespannt mit elastischen Gewebegurten.

**AUFBAU** | Polyurethanschaum in verschiedenen Raumgewichten, bezogen mit Polyestergewebe (200g/m2)

**RÜCKENKISSEN** | 100% Baumwollunterbezug mit "rollofil" Flocken.

**FÜßE** | Aluminium schwarzchrom.

**BEZUG** | In Stoff komplett abziehbar, Leder festgepolstert.

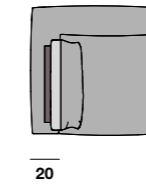
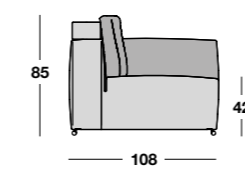

Sofas

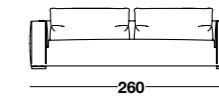
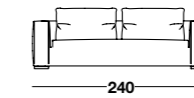
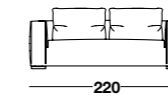
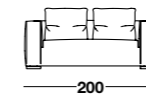

Left and Right elements

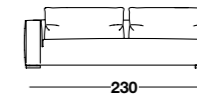
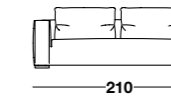
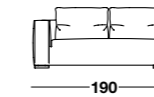
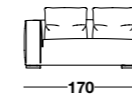

Central elements

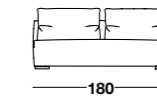
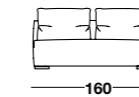
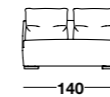

Left and Right open elements

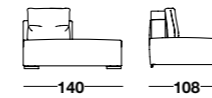

108

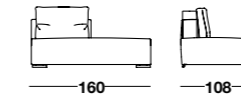

108

Chaise Longue

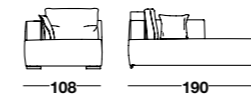

190

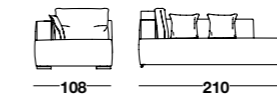

210

Corner

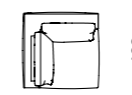

Long Corner

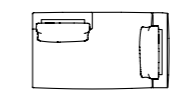
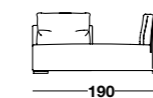
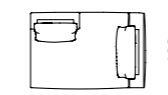
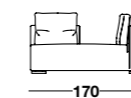

Pouf

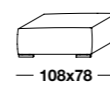

108x78

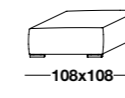

108x108

# Cloud

Sofa



Design\_Enrico Cesana

**STRUTTURA** | legno di abete (Picea Abies) e multistrato, con cinghie elastiche.

**IMBOTTITURA STRUTTURA** | poliuretano espanso a densità differenziate, rivestito con fodera in fibra di poliestere resinata da 100 gr/m2 accoppiata a tessuto in poliestere elasticizzato.

**CUSCINI SEDUTA E SCHIENALE** | topper realizzato con inserto in espanso e con microsfere di poliestere "rollofill".

**RIVESTIMENTO** | completamente sfoderabile in tessuto, fisso in pelle.

**FRAME** | fir-wood (Picea Abies) and plywood with elastic straps.

**FRAME PADDING** | polyurethane foam with different density layers, upholstered with 100 gr/m2 resin-bonded polyester coupled with elastic polyester fabric.

**SEAT AND BACK CUSHIONS** | topper crafted with soft foam and "rollofill" polyester.

**COVER** | fabric completely removable, fixed in leather.

**GESTELL** | Massive Fichte (Picea Abies) mit Multiplex, bespannt mit elastischen Gewebegurten.

**AUFBAU** | Polyurethanschaum in verschiedenen Raumgewichten, bezogen mit Polyestergewebe (100g/m2).

**SITZ-RÜCKENAUFLAGE** | Topper mit Schaumstoffeinlage und „rollofill“ – Flocken.

**BEZUG** | in Stoff komplett abziehbar, Leder festgepolstert.

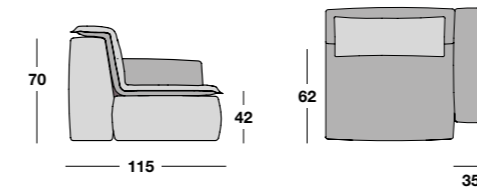

Sofas

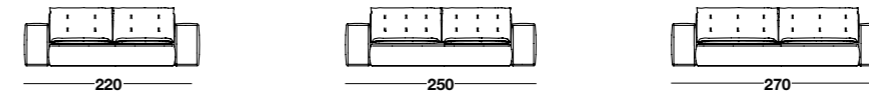

Left and Right elements

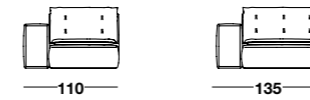

Central elements



Chaise Longue

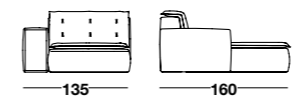

Dormeuse

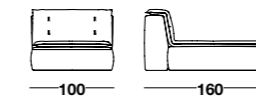

Corner

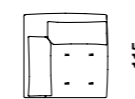
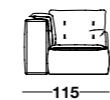

Long Corner

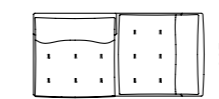
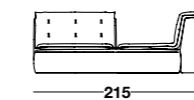

Pouf

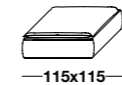
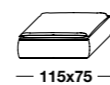

# Mistral

Sofa



Design\_Enrico Cesana

**STRUTTURA** | legno di abete (Picea Abies) e multistrato, con cinghie elastiche.

**IMBOTTITURA STRUTTURA** | poliuretano espanso a densità differenziate, rivestito con fodera in fibra di poliestere resinata da 100 gr/m2 accoppiata a tessuto in poliestere elasticizzato.

**CUSCINI SCHIENALE** | fodera in cotone 100% con microsfere di poliestere "rollofill".

**RIVESTIMENTO** | completamente sfoderabile in tessuto, fisso in pelle.

**FRAME** | fir-wood (Picea Abies) and plywood with elastic straps.

**FRAME AND SEAT PADDING** | polyurethane foam with different density layers, upholstered with 100 gr/m2 resin-bonded polyester coupled with fabric in elastic polyester.

**BACK CUSHIONS** | 100% cotton cover with "rollofill" polyester.

**COVER** | fabric completely removable, fixed in leather.

**GESTELL** | Massive Fichte (Picea Abies) mit Multiplex, bespannt mit elastischen Gewebegurten.

**AUFBAU** | Polyurethanschaum in verschiedenen Raumgewichten, bezogen mit Polyestergewebe (100g/m2)

**RÜCKENKISSEN** | 100% Baumwollunterbezug mit „rollofil“, Flocken.

**BEZUG** | In Stoff komplett abziehbar, Leder festgepolstert.

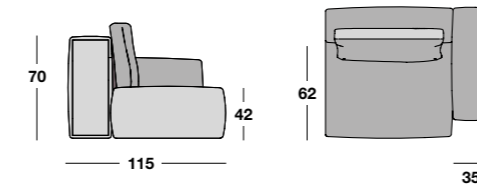

Sofas

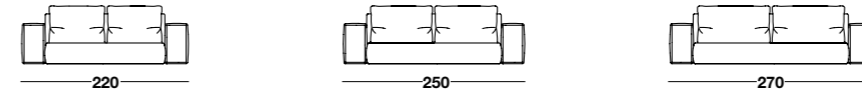

Left and Right elements



Central elements



Chaise Longue

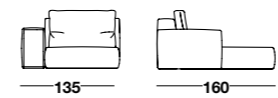

Dormeuse

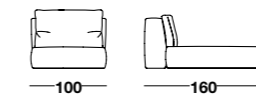

Corner



Long Corner

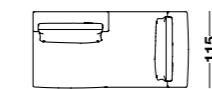
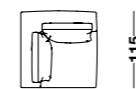
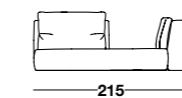

Pouf

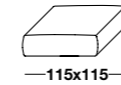
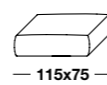

# Aland

Sofa



Design\_ Enrico Cesana

**STRUTTURA** | legno di abete (Picea Abies) e multistrato, con cinghie elastiche.

**IMBOTTITURA SCHIENALE** | poliuretano espanso a densità differenziate rivestito con fibra in poliestere resinata da 200 gr/mt2 accoppiata a tessuto in poliestere elasticizzato.

**SEDUTA** | poliuretano espanso a densità differenziate e "memory foam", rivestito con con fibra in poliestere resinata da 200 gr/mt2 accoppiata a tessuto in poliestere elasticizzato.

**CUSCINI SCHIENALE** | fodera in 100% cotone imbottita con microsfere di poliestere "rollofil".

**RIVESTIMENTO** | non sfoderabile, sia in tessuto che in pelle.

**FRAME** | fir-wood (Picea Abies) and plywood with elastic straps.

**BACK PADDING** | polyurethane foam with different layers, covered with 200gr/M2 resin-bonded polyester coupled with elastic polyester fabric.

**SEAT** | polyurethane foam with different layers and "memory foam", covered with 200gr/M2 resin-bonded polyester coupled with elastic polyester fabric.

**BACK CUSCHIONS** | 100% cotton cover, padded with "rollofil" polyester.

**COVERS** | fixed both in fabric and in leather, not removable.

**UNTERBAU** | Gewebegurten auf Holzgestell in Polyurethanschaum geschäumt.

**SITZKISSEN** | Polyurethanschaum geschäumt.

**RÜCKENKISSEN** | Lose Rückenkissen in Gänsedaunen.

**BEZUG** | Festgepolstert sowohl in Stoff als auch in Leder.

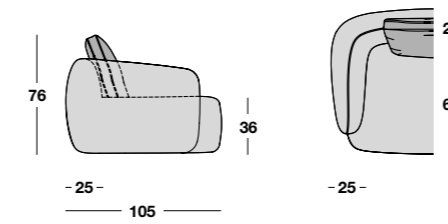

Sofas

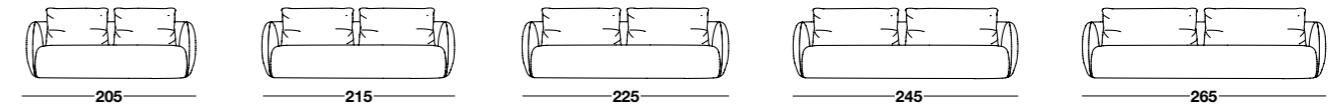

Left and Right elements



Central elements

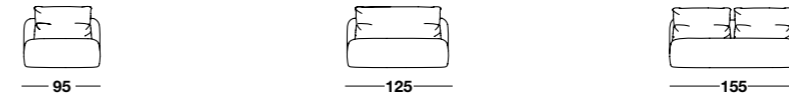

Left and Right open elements



Chaise Longue

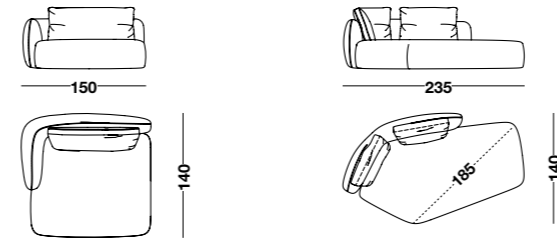

Corner

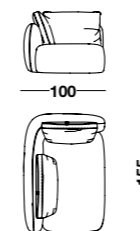

# Aland\_Armchair

Armchair

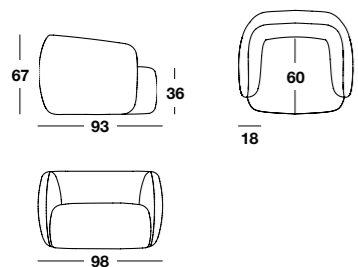

**STRUTTURA** | legno di abete (Picea Abies) e multistrato, con cinghie elastiche.

**IMBOTTITURA SCHIENALE** | poliuretano espanso a densità differenziate rivestito con fibra in poliestere resinata da 200 gr/mt2 accoppiata a tessuto in poliestere elasticizzato.

**SEDUTA** | poliuretano espanso a densità differenziate e "memory foam", rivestito con con fibra in polie- stere resinata da 200 gr/mt2 accoppiata a tessuto in poliestere elasticizzato.

**RIVESTIMENTO** | non sfoderabile, sia in tessuto che in pelle.

**FRAME** | fir-wood (Picea Abies) and plywood with elastic straps.

**BACK PADDING** | polyurethane foam with different layers, covered with 200gr/M2 resin-bonded polyester coupled with elastic polyester fabric.

**SEAT** | polyurethane foam with different layers and "memory foam", covered with 200gr/M2 resin-bonded polyester coupled with elastic polyester fabric.

**COVERS** | fixed both in fabric and in leather, not removable.

**UNTERBAU** | Gewebegurten auf Holzgestell in Polyurethanschaum geschäumt.

**SITZKISSEN** | Polyurethanschaum geschäumt.

**BEZUG** | Festgepolstert sowohl in Stoff als auch in Leder.

Design\_Enrico Cesana

# Bumper

Armchair

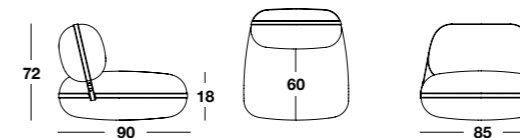

**STRUTTURA** | legno di abete (Picea Abies) e multistrato, con cinghie elastiche.

**IMBOTTITURA** | poliuretano espanso a densità differenziate, rivestito con fodera in fibra di poliestere resinata da 100 gr/m2 accoppiata a tessuto in poliestere elasticizzato.

**RIVESTIMENTO** | fisso in tessuto ed in pelle.

**CINGHIE DECORATIVE** | realizzate con rivestimento della poltrona oppure con pelle Siviglia nei colori Ghiaia, Ebano, Antracite o con pelle Nappa nei colori Cuoio,

Burro, Antracite. Versione Plus con base girevole in metallo.

**FRAME** | fir-wood (Picea Abies) and plywood with elastic straps.

**PADDING** | polyurethane foam, upholstered with 100 gr/m2 resin-bonded polyester coupled with fabric in elastic polyester.

**COVER** | fixed both in fabric and in leather.

**DECORATIVE STRAP** | crafted with the same material used for armchair otherwise with leather Siviglia, colors Ghiaia, Ebano, Antracite or leather Nappa, colors Cuoio,

Burro, Antracite. "Plus" version, with metal swivel base

**GESTELL** | Massive Fichte ( Picea Abies ) mit Multiplex, bespannt mit elastischen Gewebegurten. AUFBAU: Polyurethanschaum in verschiedenen Raumgewichten,

bezogen mit Polyestergewebe (100g/m2)

**BEZUG** | In Stoff und in Leder festgepolstert

**DEKORATIVBÄNDER** | In Stoff oder Leder des Sessels, oder mit Siviglia-Leder, Farben Ghiaia, Ebano, Antracite, oder mit Nappa-Leder, Farben Cuoio,

Burro, Antracite. "Plus" version, mit Drehbarer

# Bumper\_Lounge

Chaise Longue



**STRUTTURA** | legno di abete (Picea Abies) e multistrato, con cinghie elastiche.

**IMBOTTITURA** | poliuretano espanso a densità differenziate, rivestito con fodera in fibra di poliestere resinata da 100 gr/m2 accoppiata a tessuto in poliestere elasticizzato.

**RIVESTIMENTO** | fisso in tessuto ed in pelle.

**CINGHIE DECORATIVE** | realizzate con rivestimento della poltrona oppure con pelle Siviglia nei colori Ghiaia, Ebano, Antracite o con pelle Nappa nei colori Cuoio,

Burro, Antracite.

**FRAME** | fir-wood (Picea Abies) and plywood with elastic straps.

**PADDING** | polyurethane foam, upholstered with 100 gr/m2 resin-bonded polyester coupled with fabric in elastic polyester.

**COVER** | fixed both in fabric and in leather.

**DECORATIVE STRAP** | crafted with the same material used for armchair otherwise with leather Siviglia, colors Ghiaia, Ebano, Antracite or leather Nappa, colors Cuoio,

Burro, Antracite.

**GESTELL** | Massive Fichte ( Picea Abies ) mit Multiplex, bespannt mit elastischen Gewebegurten.

**AUFBAU** | Polyurethanschaum in verschiedenen Raumgewichten, bezogen mit Polyestergewebe (100g/m2)

**BEZUG** | In Stoff und in Leder festgepolstert

**DEKORATIVBÄNDER** | In Stoff oder Leder des Sessels, oder mit Siviglia-Leder, Farben Ghiaia, Ebano, Antracite, oder mit Nappa-Leder, Farben Cuoio, Burro, Antracite.

Design\_Enrico Cesana

Design\_Enrico Cesana

# Dover

Armchair

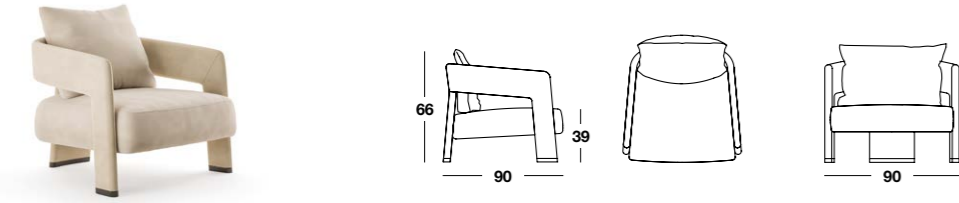

**STRUTTURA** | legno di abete e multistrato curvato. **IMBOTTITURA STRUTTURA** | poliuretano espanso.

**SEDUTA** | poliuretano espanso a densità differenziate. **CUSCINI SCHIENALE** | fodera in 100% cotone imbottita con microsfere di poliestere "rollofil".

**PIEDI** | estrusione di alluminio, finitura nickel nero. **RIVESTIMENTO** | fisso in tessuto ed in pelle.

**FRAME** | fir-wood (Picea Abies) and plywood. **FRAME PADDING** | polyurethane foam.

**SEAT CUSHION** | polyurethane foam with different density layers. **BACK CUSHION** | 100% cotton cover, padded with "rollofil" polyester.

**FEET** | aluminium extrusion with black nickel finish. **COVER** | fixed both in fabric and leather.

**GESTELL** | Massive Fichte (Picea Abies) mit gebogenem Multiplex und Polyurethan-Schaum.

**SITZ** | Polyurethanschaum in verschiedenen Raumgewichten, bezogen mit Polyestergewebe 100g/m2.

**RÜCKENKISSEN** | 100% Baumwollunterbezug mit "rollofil" Flocken. **FÜßE** | Aluminium schwarzchrom. **BEZUG** | In Stoff und Leder festgepolstert.

# Leslie

Swivel Armchair

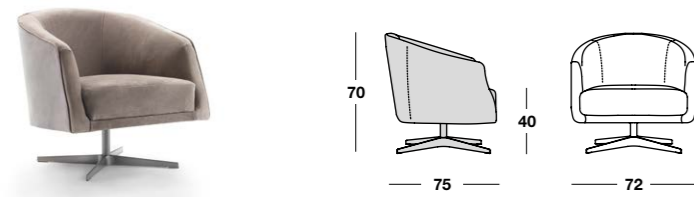

**STRUTTURA** | legno di abete (Picea Abies) e multistrato, con cinghie elastiche.

**IMBOTTITURA STRUTTURA** | poliuretano espanso a densità di erenziate, rivestito con fodera in bra di poliestere resinata da 100 gr/m2 accoppiat a a tessuto in poliestere elasticizzato. **BASE** | base girevole in metallo. **RIVESTIMENTO** | fisso in tessuto e in pelle.

**FRAME** | fir-wood (Picea Abies) and plywood with elastic straps.

**FRAME PADDING** | polyurethane foam, upholstered with 100 gr/m2resin-bonded polyester coupled with fabric in elastic polyester.

**BASE** | metal swivel base. **COVER** | fixed both in fabric and in leather.

**UNTERBAU** | Gewebegurten auf Holzgestell mit Schichtholzverkleidung bezogen mit Polyurethanschaum in verschiedenen Raumgewichten.

**SITZKISSEN** | Sandwichkissen mit Schaumkern 420gr/m2 und Watteabdeckung mit Baumwollbezug.

**KISSEN** | Gänsedaunen, abgekammert mit Baumwollbezug. **GESTEL** | Metallgestell, drehbar. **BEZUG** | Festgepolstert, sowohl in Stoff als auch in Leder.

Design\_Enrico Cesana

# Island

Coffee Tables



Coffee tables

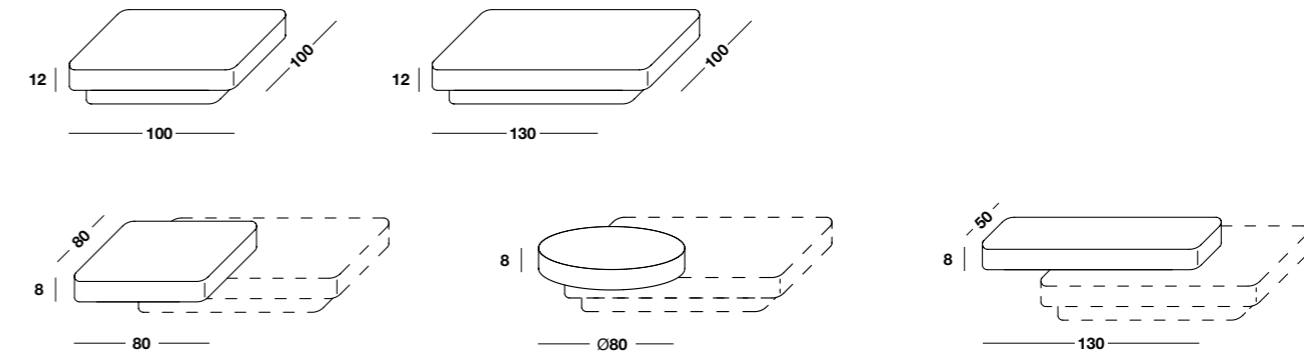

Collezione di tavolini laccati color Pepe, Mattone e Muschio, oppure in rovere, finitura naturale o color noce.

Collection of coffee tables lacquered in Pepe, Mattone and Muschio colour, or with Oak Wood, natural or walnut finish.

Kollektion von Couchtischen lackiert in den Farben Pepe, Mattone und Muschio, oder in Eiche, Natur oder Nussbaumfarbig.



PEPE

MUSCHIO

MATTONE

Design\_Marac Lab

Design\_Enrico Cesana

# Elliot & Elliot\_Colours

Coffee Tables

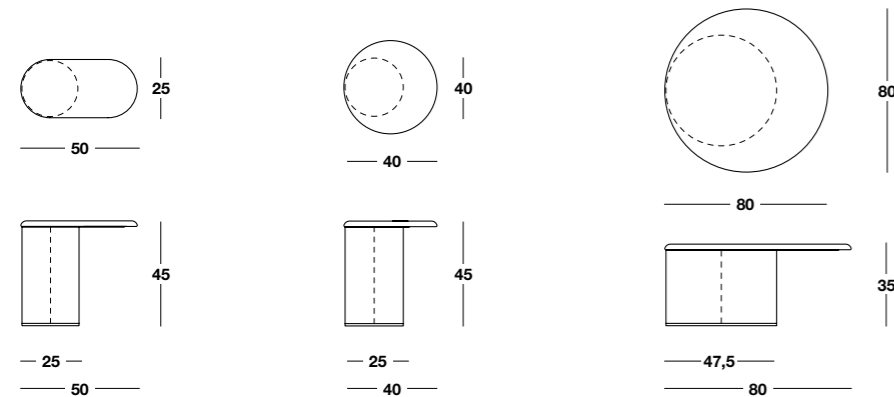

## ELLIOT

Tavolini con base cilindrica realizzata con multistrato curvato e rivestito in cuoio, nei colori Grafite, Tortora e Caramello; top in marmo (spessore 20 mm) Calacatta Oro o Orobico Arabescato

Coffee tables with cylindrical base made with curved ply wood and covered with leather color Grafite, Tortora or Caramello; top with Calacatta Gold or Orobico Arabescato marble (20 mm thickness)

Couchtische mit zylindrischem Sockel aus gebogenem Multiplex, bezogen mit Kernleder in den Farben Grafite, Tortora oder Caramello; Platte aus Marmor Calacatta Gold oder Orobico Arabescato (20 mm Stärke)

## ELLIOT\_COLOURS

Tavolini con base cilindrica realizzata con multistrato curvato e con top in mdf, tutto completamente laccato con finitura opaca o lucida nei colori da campionario.

Coffee tables with cylindrical base made with curved plywood and top with mdf, lacquered with colours available from collection, matt or glossy finish.

Couchtische mit zylindrischem Sockel aus gebogenem Multiplex und Platte aus MDF, lackiert in den angebotenen Farben mit matter oder glänzender Oberfläche.



OLTREMARE PEPE MUSCHIO MATTONE PIOGGIA

Design\_Enrico Cesana

# Boulevard

Coffee Tables



## Coffee tables

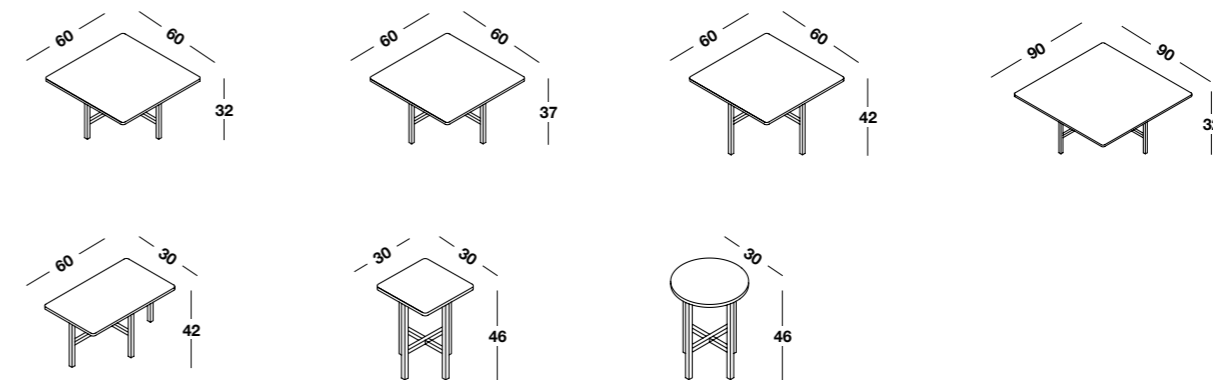

## Consolle

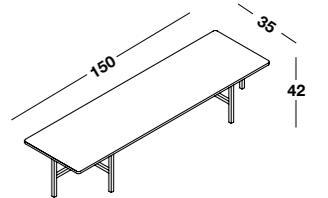

Tavolini e consolle con base in tubolare metallico Ø 10mm e top in mdf con varie finiture.

Finitura Pietra: granaglia di pietre e marmi spatolati manualmente nelle finiture Lava Rock, Dark Grey, Candoglia; base color Nero opaco.

Finitura Resina: resina colorata Rosso Oriente spatolata manualmente e poliesteri; base color Nero opaco.

Finitura Laccata: laccatura opaca o lucida nei colori da campionario; base color Nero opaco o nei colori da campionario con finitura opaca.

Coffee table and console with Ø 10 mm metal base and top with mdf with variety of finishes.

Stone finish: granulated marbles and stones, spread by hand, in Lava Rock, Dark Grey, Candoglia finishes; Matt Black color for the base.

Resin finish: colored Rosso Oriente resin, spread by hand, and polyester; Matt Black color for the base.

Lacquered finish: matt or glossy lacquered colors available from collection; base with matt black or colors available from collection with matt finish

Couchtische und Konsole mit Metallgestell Ø 10 mm in schwarz matt, Platte aus MDF in verschiedenen

Ausführung Stein: granulierter Marmor, in den Ausführungen Lava Rock, Dark Grey, Candoglia.

Ausführung Kunstharz-Finish: gefärbtes Harz Rosso Oriente, mit Polyester bezogen.

Lackierte Ausführung: lackiert in den angebotenen Farben mit matter oder glänzender Oberfläche, hier das Metallgestell in den Farben Schwarz oder in den angebotenen Farben mit matter Oberfläche.



OLTREMARE PEPE MUSCHIO MATTONE PIOGGIA ROSSO ORIENTE DARK GREY LAVA ROCK CANDOGLIA



# Mik

Coffee Tables

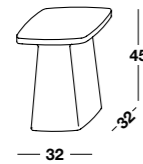
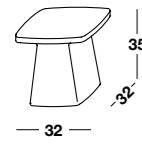

Tavolino in legno tornito, laccato con finitura opaca o lucida nei colori da campionario

Wooden small table, lacquered with matt or glossy finish, colors available from collection

Beistelltisch aus Holz, lackiert in matt oder hochglanz, Farben nach Muster.



OLTREMARE PEPE MUSCHIO MATTONE PIOGGIA

Design\_Enrico Cesana

# Lain

Pouf

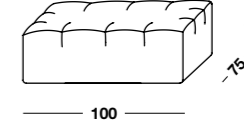
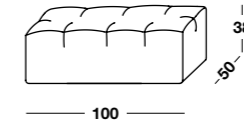
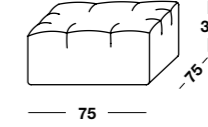
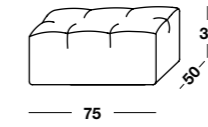

Pouf realizzato con struttura di poliuretano espanso ad alta densità, rivestito con poliestere resinato da 300gr/mt2 e fissato su basamento in multistrato da 15 mm. Rivestimento fisso.

Ottoman with frame made of high density polyurethane foam, covered with 300 gr/mt2 resin-bonded polyester, fixed on 15 mm thick plywood base. Fixed cover.

Hocker aus hochdichtem Polyurethanschaum, bezogen mit harzgebundenem Polyester von 300gr/m2, befestigt auf einer 15mm Sperrholzplatte. Bezug fest.

Design\_Marac Lab

**AD** / Enrico Cesana

**Graphic** / CO3 Design Studio

**Styling** / Massimiliano Di Domenico

**Render images** / Virtual Design

**Prepress** / CD Cromo

**Printing** / Grafica Goia

Giugno 2023



Via Milano, 74  
22063 Cantù (CO) Italy  
T +39 031 711349  
[www.marac.it](http://www.marac.it)  
[info@marac.it](mailto:info@marac.it)

